

HORIZON

Wide range of optics to provide incomparable control of light

Flexibility of installation with multiple mounting options available

Up to 20 feet long throw with narrow optics

Application



Wall grazing



Wall washing



Diffused lighting

Optical distributions

7° with narrow beam filter

7D-NBF

LIGHT BEAM

SIDE VIEW

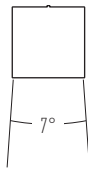

FRONT VIEW

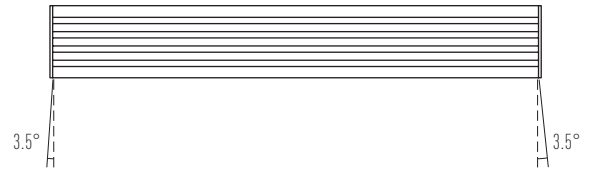

11° with narrow beam filter

11D-NBF

LIGHT BEAM

SIDE VIEW

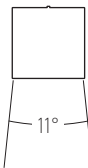

FRONT VIEW

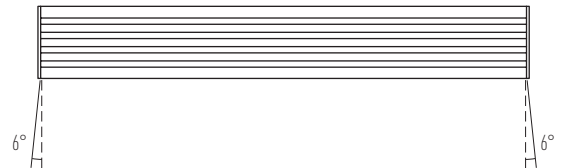

28° with narrow beam filter

28D-NBF

LIGHT BEAM

SIDE VIEW

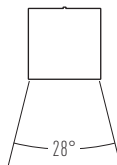

FRONT VIEW

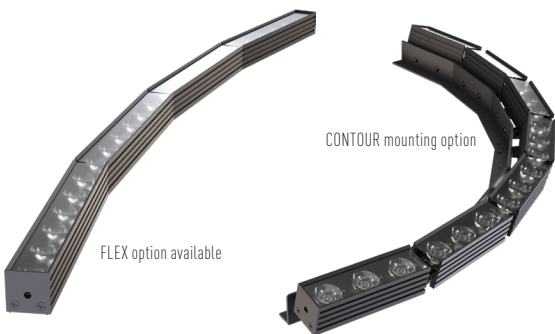
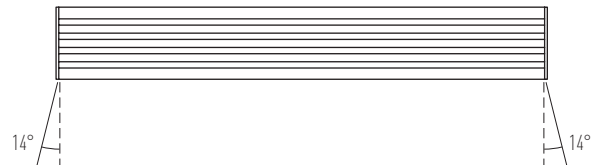

MADE IN
FABRIQUE AU CANADA

ROHS
COMPLIANT

UL
US

CE FC

42° with narrow beam filter

42D-NBF

LIGHT BEAM



8°x52° with linear optic filter

8X52D-LOF

LIGHT BEAM

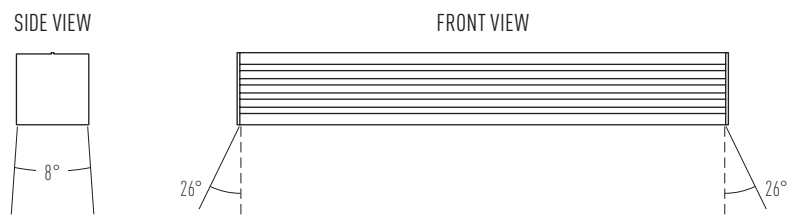

Physical

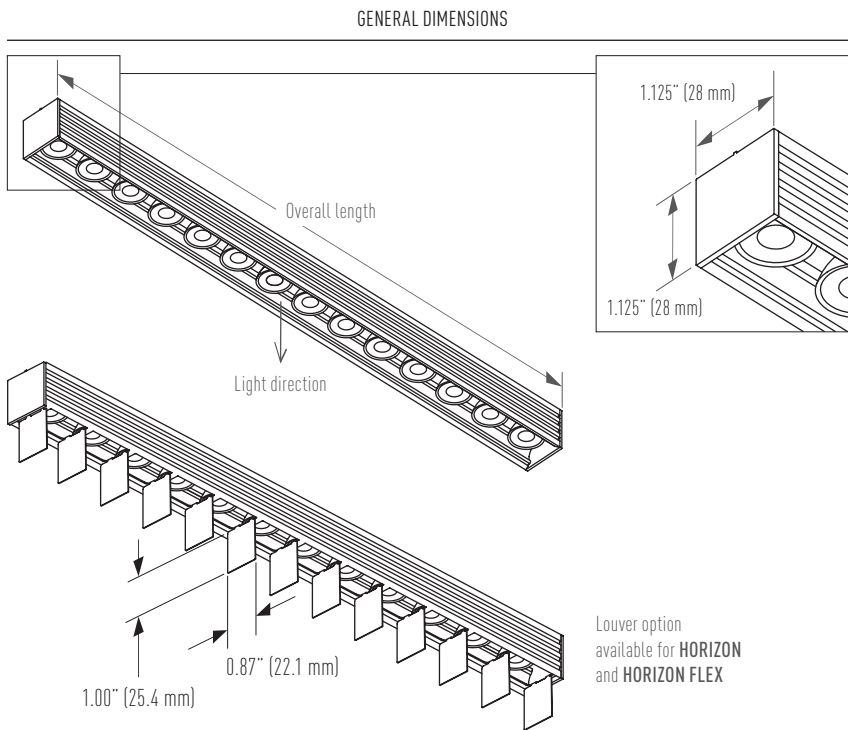

Finish

ABK Anodized black



ACL Anodized clear



MW Matte white

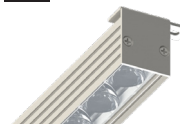

Construction

Aluminium body

PMMA optics

Weight

0.66 lbs/ft (982 g/m)

Maximum standard length

100" (2540 mm)

Ingress protection code

IP40

Operating ambient temperature

0 °C to 40 °C

Storage temperature

0 °C to 40 °C at 50% humidity.

Electrical

i This product is a **DC LED Lighting Module**. The following are required to operate as a complete system – to order separately:

Power Supply

24 VDC | Constant Voltage | PWM (if dimmable) | Remote Installation

Recommended driver: Eclipse Light Manager LM-24V.100W-[...]

[1% dim in 0-10V / DALI / Ecosystem]

Power Supply (for HORIZON CONTOUR)

12 VDC | Constant Voltage | PWM (if dimmable) | Remote Installation

Recommended driver: Eclipse Light Manager LM-12V.60W-[...]

[1% dim in 0-10V / DALI / Ecosystem]

MODULE CURRENT REGULATION

PASSIVE

DRIVER COMPATIBILITY

UNIVERSAL*

*following driver spec. req., works with all models

Input Voltage

24 VDC in Constant Voltage (HORIZON, HORIZON FLEX)

12 VDC in Constant Voltage (HORIZON CONTOUR)

Power Density

8 W/ft | 10 W/ft (26 W/m | 33 W/m)

Dimming

Capable of operating down to 0.1%

[depends on driver performance/limitations]

Wiring

UL listed, NEC art. 800 compliant CMG cable, 48"-long, 20 AWG, Red(+)/Black(-), polarized. Not approved for plenum/air handling spaces.

Safety Information

cULus Listed, CE, SELV, Class 2, Dry location

Installation

Magnetic installation (MIH, MIV) (order carbon steel band accessory separately).

Hardware installation (PILC, OLCH, OLCV, ILCH,ILCV and HORIZON CONTOUR)

Cable limit

Voltage loss tolerance due to remote driver cable course, up to -2.5 V. See LIGHT MANAGER spec for max. cable length table per AWG.

Applications

Designed for surface grazing and edge lighting.

HORIZON FLEX model

GENERAL DIMENSIONS

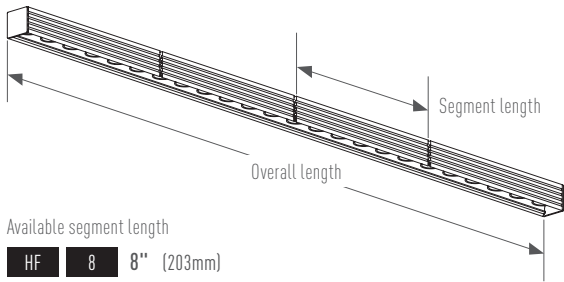

BENDING

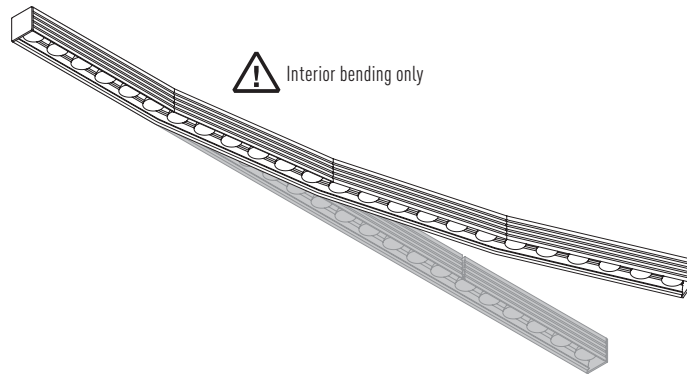

CURVE RADIUS

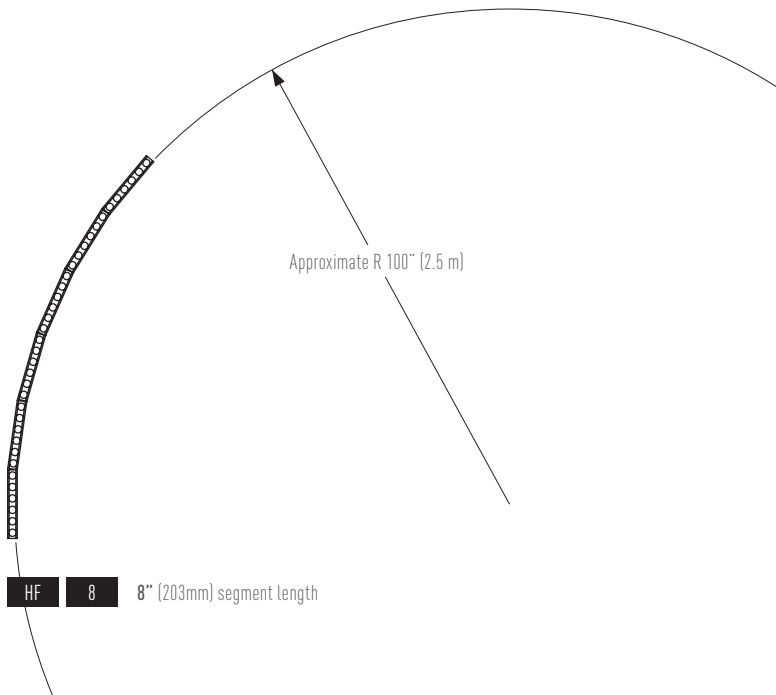

HORIZON CONTOUR model

GENERAL DIMENSIONS

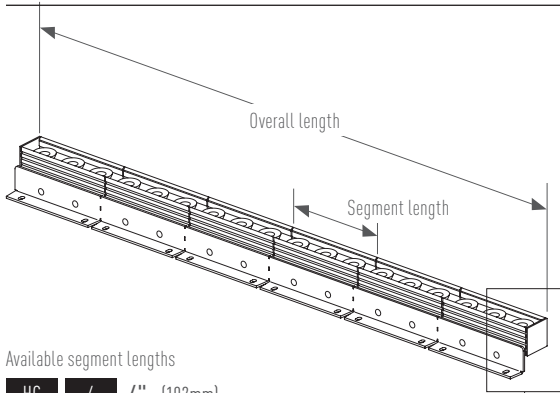

Available segment lengths

HC 4 4" (102mm)

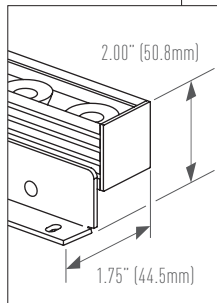

ADJUSTMENT

Each segment can be independently tilted in both directions, up to 8° interior and up to 16° exterior.

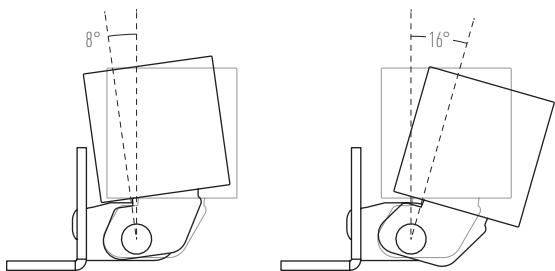

BENDING

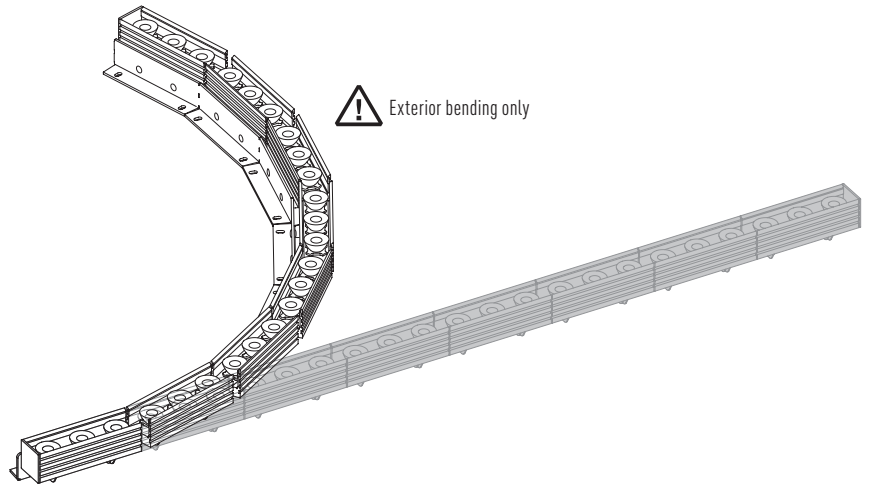

CURVE RADIUS



Wiring options

WIRE EXIT

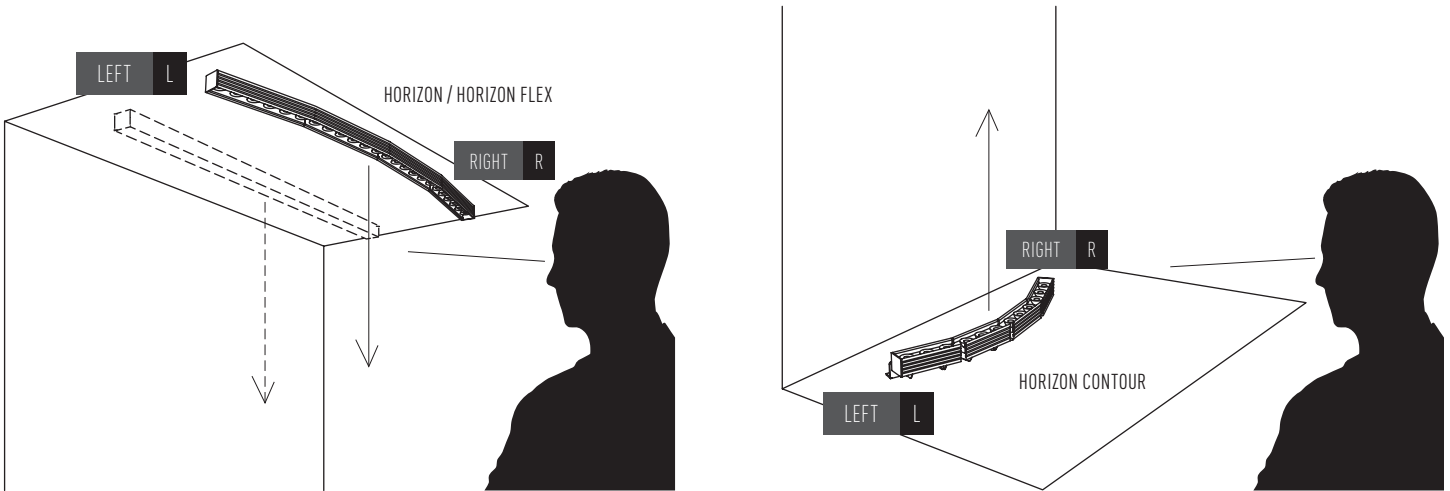

WIRE DIRECTION

Wire direction depends on the mounting options specified.

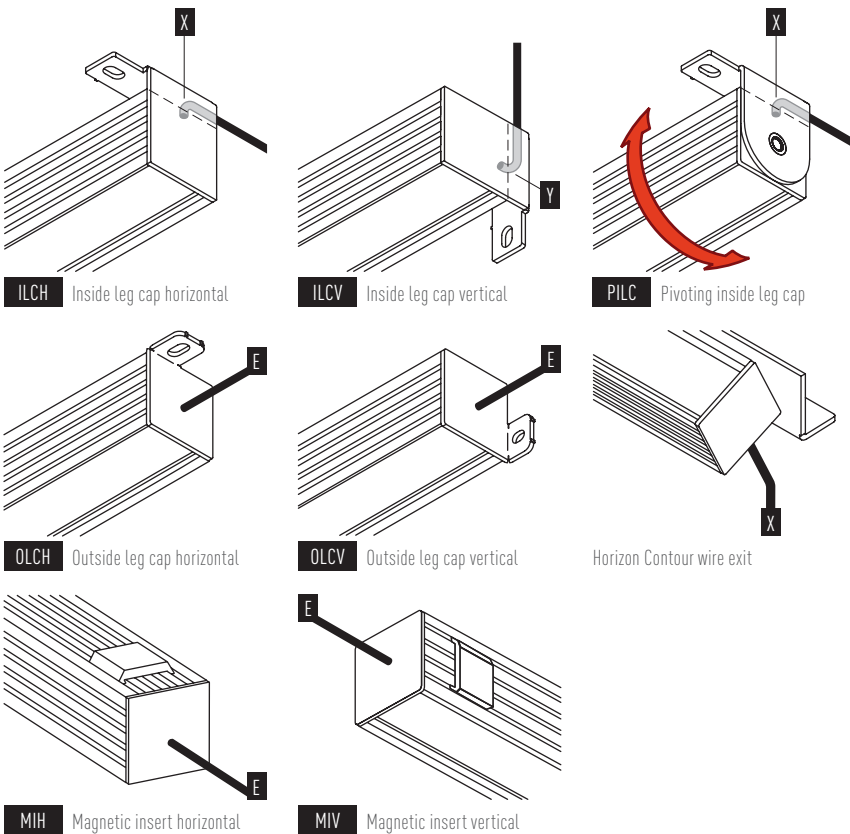

WIRE CONNECTOR

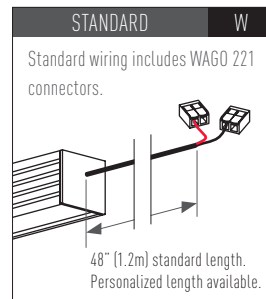
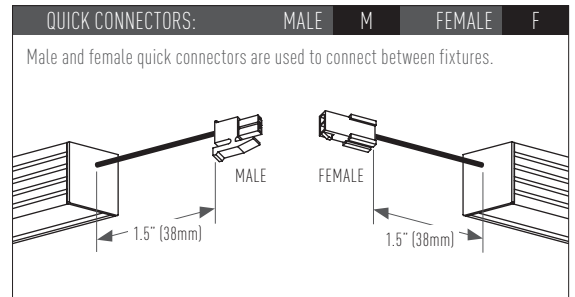

Integration overview

MAGNETIC INSTALLATION

Magnetic insert horizontal and vertical available for HORIZON and HORIZON FLEX.

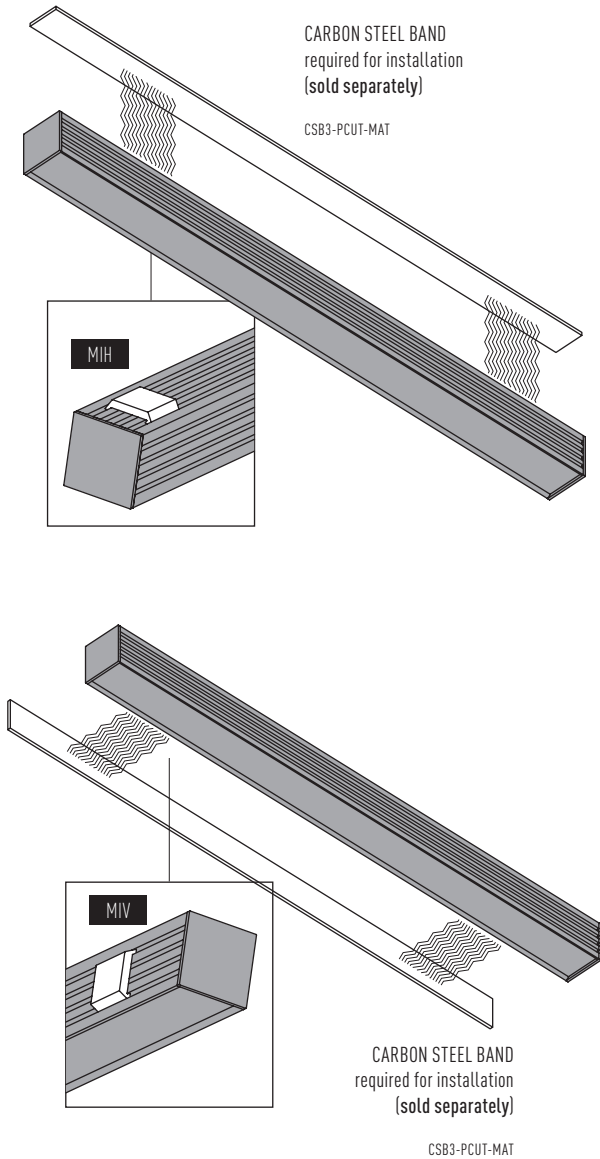

HARDWARE INSTALLATION

Installation by screws available for HORIZON and HORIZON CONTOUR.

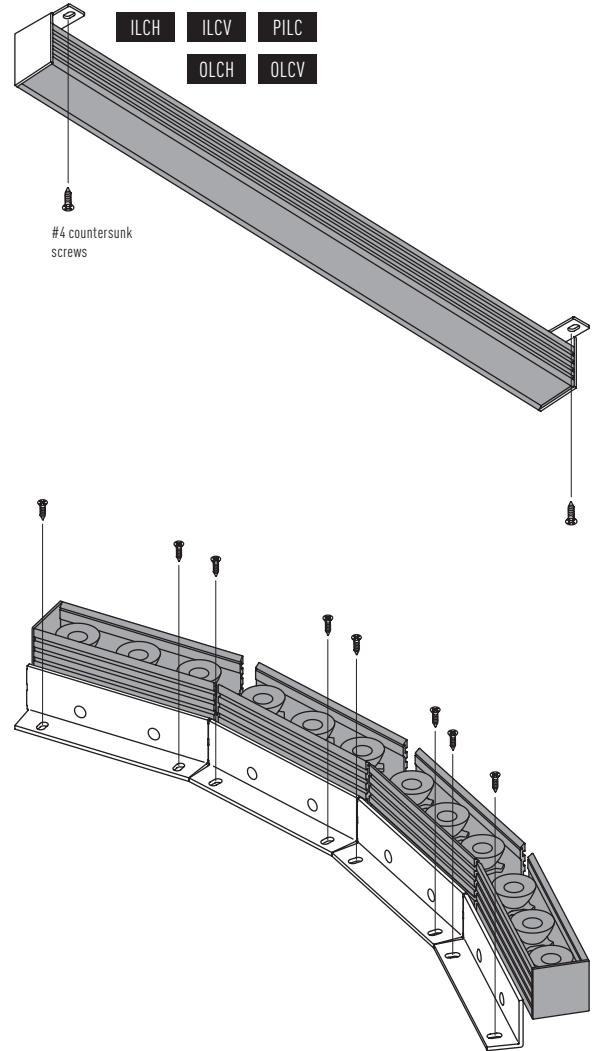

Accessories

Carbon steel band (type 3)

CSB3-PCUT-MAT

Required for magnetic installation. Pre-cut to match ordered lengths.

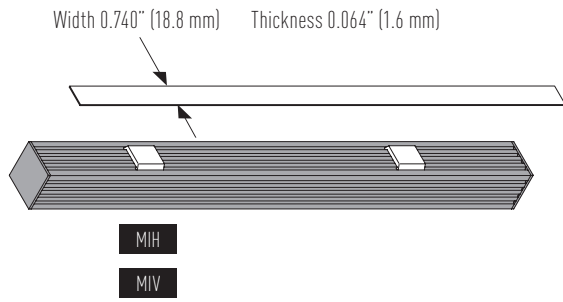

HORIZON ordering code

PRODUCT		CORE OPTIONS						EXTENDED OPTIONS								
ID	MOUNTING OPTION	INPUT	OUTPUT	FINISH	CCT	CRI	OPTIC FILM	LENGTH	WIRING OPTIONS							
H HORIZON	MIH	24V	8W	ABK	2200K	80	7D.NBF	8.3 to 96.3	ILCH, PILC							
	MIV		10W	ACL	2700K	80	11D.NBF		EXIT DIRECT. CONN. LENGTH EXIT DIRECT. CONN. LENGTH							
	PILC		Watt per foot	MW	3000K	80	28D.NBF	PILC	L	X	W	48	R	X	W	48
	ILCH			ABK	3500K	80	42D.NBF									
	ILCV			ACL	4000K	80	8X52D.LOF	OLCH, OLCV	F	1.5	CUST.	F	1.5	CUST.		
	OLCH			MW	7D.NBF.L	11D.NBF.L	28D.NBF.L								42D.NBF.L	
OLCV																

Please note that each mounting option has its selective wiring directions.

MIH Magnetic insert horizontal
MIV Magnetic insert vertical
ILCH Inside leg cap horizontal
OLCH Outside leg cap horizontal
ILCV Inside leg cap vertical
OLCV Outside leg cap vertical
PILC Pivoting leg cap
PILC Pivoting leg cap

#D Optic
NBF Narrow beam filter
LOF Linear optic filter
L Square louvers (8")

Inches Available in increment of 8".

ILCV							
EXIT	DIRECT.	CONN.	LENGTH	EXIT	DIRECT.	CONN.	LENGTH
L	Y	W	48	R	Y	W	48
			CUST.				CUST.
		M	1.5			M	1.5
		F	1.5			F	1.5
			CUST.				CUST.

MIH, MIV, OLCH, OLCV							
EXIT	DIRECT.	CONN.	LENGTH	EXIT	DIRECT.	CONN.	LENGTH
L	E	W	48	R	E	W	48
			CUST.				CUST.
		M	1.5			M	1.5
		F	1.5			F	1.5
			CUST.				CUST.

Lengths are in inches
W Standard connector - **M** Male quick connector - **F** Female quick connector
 For further details, refer to "Wiring option" section.

EXAMPLE	ORDERING CODE							INCHES		Single wire exit		or		Double wire exit	
	ID	MOUNTING OPTION	INPUT	OUTPUT	FINISH	CCT	CRI	OPTIC FILM	LENGTH	CONN.	LENGTH	CONN.	LENGTH	CONN.	LENGTH
	H	ILCH	24V	10W	ABK	3000K80		28D.NBF	88.3	LXW48	48	LXM6+RXF6	48		

Available overall lengths

MIH, MIV, ILCH, ILCV			PILC			OLCH, OLCV											
inches	mm		inches	mm		inches	mm										
8.3	211	40.3	1024	72.3	1837	8.4	214	40.4	1027	72.4	1839	9.4	237	41.4	1049	73.4	1862
16.3	414	48.3	1227	80.3	2040	16.4	417	48.4	1230	80.4	2043	17.4	440	49.4	1253	81.4	2065
24.3	618	56.3	1430	88.3	2243	24.4	620	56.4	1433	88.4	2246	25.4	643	57.4	1456	89.4	2269
32.3	821	64.3	1634	96.3	2446	32.4	823	64.4	1636	96.4	2449	33.4	846	65.4	1659	97.4	2472

HORIZON FLEX ordering code

PRODUCT			CORE OPTIONS							EXTENDED OPTIONS							
ID	SEGMENT LENGTH	MOUNTING OPTION	INPUT	OUTPUT	FINISH	CCT CRI		OPTIC FILM	LENGTH	WIRING							
HF	8	MIH MIV	24V	8W 10W	ABK ACL MW	2200K 2700K 3000K 3500K 4000K	80	7D.NBF 11D.NBF 28D.NBF 42D.NBF 8X52D.LOF 7D.NBF.L 11D.NBF.L 28D.NBF.L 42D.NBF.L	16.5 to 73.8	EXIT	DIRECT.	CONN.	LENGTH	EXIT	DIRECT.	CONN.	LENGTH
	In inches	MIH Magnetic insert horizontal MIV Magnetic insert vertical		Watt per foot	ABK Anodized black ACL Anodized clear MW Matte white				In inches Available in increment of 8". (See available lengths)	L	E	W M F	48 CUST. 1.5 CUST. 1.5 CUST.	R	E	W M F	48 CUST. 1.5 CUST. 1.5 CUST.

Lengths are in inches
W Standard connector - **M** Male quick connector - **F** Female quick connector
 Refer to "Wiring option" section for details.

ORDERING CODE EXAMPLE	HF	-	8	-	MIH	-	24V	-	10W	-	ABK	-	3000K80	-	28D.NBF	-	INCHES	57.4	-	Single wire exit	or	Double wire exit
																				LEW48		LEM6+REF6

Available overall lengths

Single wire exit				Double wire exit			
inches	mm	inches	mm	inches	mm	inches	mm
16.5	419	49.3	1250	16.6	422	49.4	1253
24.7	627	57.4	1458	24.8	630	57.6	1461
32.9	835	65.6	1666	33.0	838	65.7	1669
41.1	1042	73.8	1874	41.2	1046	73.9	1877

HORIZON CONTOUR ordering code

PRODUCT		CORE OPTIONS						EXTENDED OPTIONS																																	
ID	SEGMENT LENGTH	INPUT	OUTPUT	FINISH	CCT	CRI	OPTIC FILM	LENGTH	WIRING																																
HC	4	12V	8W 10W	ABK ACL MW	2200K 2700K 3000K 3500K 4000K	80	7D.NBF 11D.NBF 28D.NBF 42D.NBF 8X52D.LOF	8.5 to 63.8	<table border="1"> <thead> <tr> <th>EXIT</th> <th>CONN.</th> <th>LENGTH</th> <th>EXIT</th> <th>CONN.</th> <th>LENGTH</th> </tr> </thead> <tbody> <tr> <td rowspan="3">L</td> <td rowspan="2">W</td> <td>48</td> <td rowspan="2">R</td> <td rowspan="2">W</td> <td>48</td> </tr> <tr> <td>CUST.</td> <td>CUST.</td> </tr> <tr> <td>M</td> <td>1.5</td> <td>M</td> <td>M</td> <td>1.5</td> </tr> <tr> <td rowspan="2">F</td> <td rowspan="2">1.5</td> <td>CUST.</td> <td rowspan="2">F</td> <td rowspan="2">F</td> <td>CUST.</td> </tr> <tr> <td>CUST.</td> <td>CUST.</td> </tr> </tbody> </table>						EXIT	CONN.	LENGTH	EXIT	CONN.	LENGTH	L	W	48	R	W	48	CUST.	CUST.	M	1.5	M	M	1.5	F	1.5	CUST.	F	F	CUST.	CUST.	CUST.
EXIT	CONN.	LENGTH	EXIT	CONN.	LENGTH																																				
L	W	48	R	W	48																																				
		CUST.			CUST.																																				
	M	1.5	M	M	1.5																																				
F	1.5	CUST.	F	F	CUST.																																				
		CUST.			CUST.																																				
In inches		Watt per foot		ABK Anodized black			#D Optic	In inches Available in increment of 4". (See available lengths)	Lengths are in inches W Standard conn. - M Male quick conn. - F Female quick conn. For further details, refer to "Wiring option" section.																																
				ACL Anodized clear			NBF Narrow beam filter																																		
				MW Matte white			LOF Linear optic filter																																		

ORDERING CODE	EXAMPLE	HC	-	4	-	12V	-	10W	-	ABK	-	3500K80	-	11D-NBF	-	INCHES 42.5	-	Single wire exit LW48	or	Double wire exit LM6+RF6
			-		-		-		-		-		-		-		-			
			-		-		-		-		-		-		-		-			
			-		-		-		-		-		-		-		-			

Available overall lengths

inches	mm	inches	mm	inches	mm	inches	mm
8.5	216	25.5	648	42.5	1080	59.5	1512
12.8	324	29.8	756	46.8	1188	63.8	1620
17.0	432	34.0	864	51.0	1296		
21.3	540	38.3	972	55.3	1404		

ARCHITECTURAL LIGHTING **EKLIPSE**

2090 rue Moreau
 Suite 100
 Montréal, QC - H1W 2M3
 Canada

T +1 514 590 0099
 INT 1 877 590 0099
 F +1 514 590 0098
 sales@eklipselighting.com
 www.eklipselighting.com



Warranty

Our products and relative parts are guaranteed for **three (3) years**. See our terms and conditions on www.eklipselighting.com